



WT 30 XEL WET&DRY 220-240/50-60 -LAVOR-

Filtri: validità 14/03/2023



14/03/2023

8.253.0009 - WT 30 XEL WET&DRY 220-240/50-60 -LAVOR-.....	3
R82530009 - WT 30 XEL WET&DRY 220-240/50-60 -LAVOR-.....	4
Indice componenti.....	6

Pos.	Codice	Descrizione
.	R82530009	WT 30 XEL WET&DRY 220-240/50-60 -LAVOR-

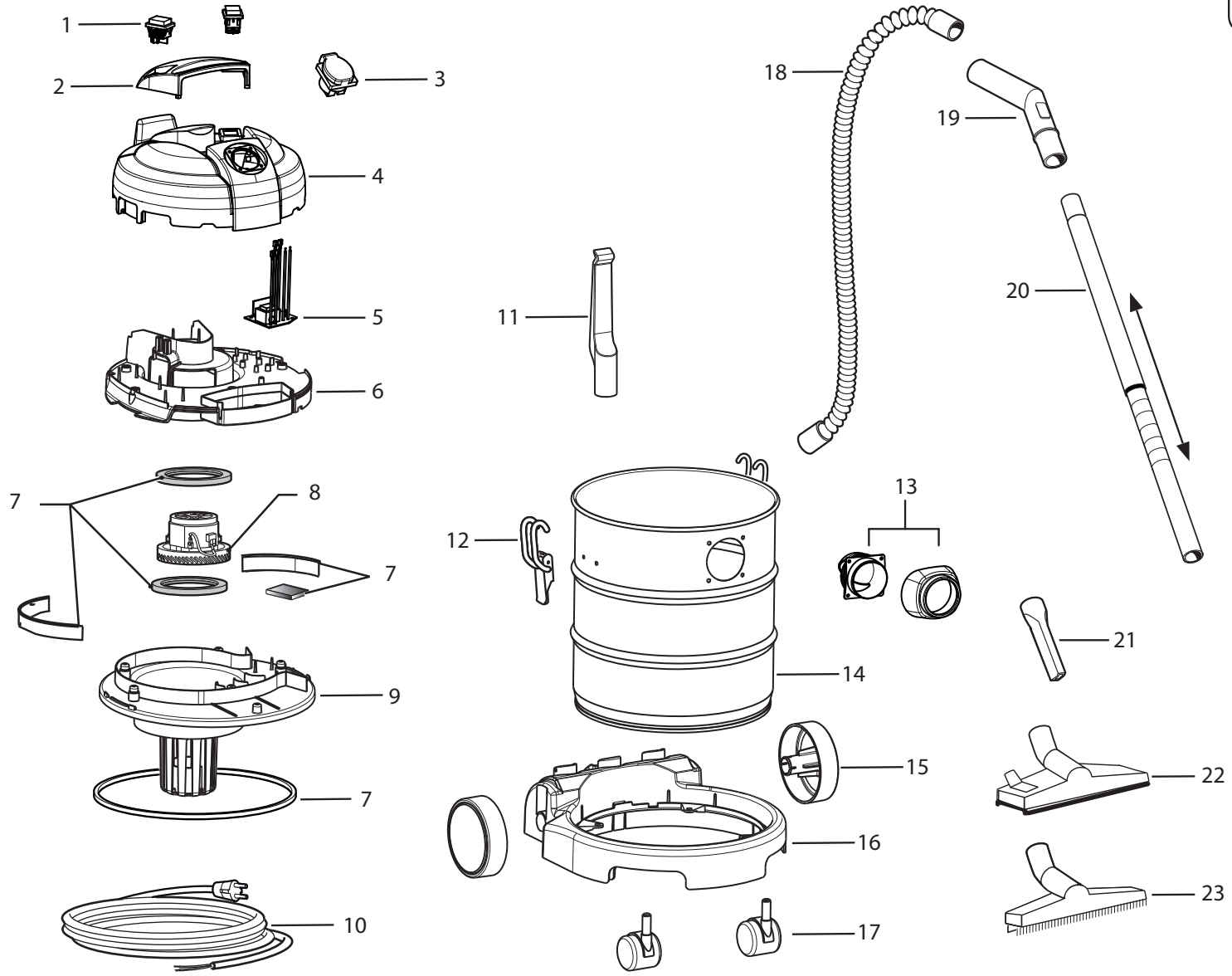
D82530009/01

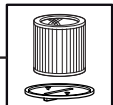

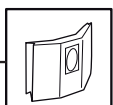
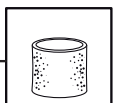
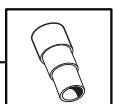
- 24 —  MANUAL
- 25 — 
- 26 — 
- 27 — 
- 28 — 
- 29 — 

Pos.	Codice	Sostituito da	Q.tà	Acquistabile	Q.tà min.	Per manuten.	Descrizione
001	5.009.0213		2	Si	1	EXT	ASSIEME INTERR. 0/1 BIP. 12(10)A +PROTEZ.TRASPARENTE
002	4.208.0772		1	Si	1		MANIGLIA X PRESA ELETTR. WINDY IF 135 (P82.0487) -G- PANT.108C
003	3.099.0138		1	Si	1	EXT	PRESA UTENSILE 50X50 IP44 SCHUKO 83944 NERA C/GUARNIZIONE
004	4.208.0771		1	Si	1		TESTATA WINDY IF 135 C/PRESA+2INT. GR.SC. C/TAMPLAVOR+MADE IN ITALY
005	3.403.0026		1	Si	1	EXT	SCHEDA ELETTR. 230/50 S/RITARDO 2200W C/CAVETTI X ASP.C/PRESA
006	4.208.0692		1	Si	1		CONVOGLIATORE ARIA ASPIRATORE NERO X WINDY 120/130
007	6.205.0215		1	Si	1	EXT	KIT SPUGNE/GUARNIZIONI X ASP. HOBBY GAMMA WT20/30
008	3.755.0085		1	Si	1	EXT	MOTORE SPAZ.MONOST. 220-240V 50/60Hz 800W C/CAV.+F.ANTID.
009	5.211.0040		1	Si	1		CALOTTA INFERIORE COMPLETA C/GALLEGG. X P82.0369 -G- PANT.108C
010	4.012.0353		1	Si	1		CAVO H05VV-F 3X1,5 MT.5,5 SP.SCHUKO ANTISPRUZZO X ASP.C/PRESA ELETTR.
011	4.208.0717		1	Si	1		GANCIO X TUBO FLEX WINDY 120/130
012	3.099.0454		2	Si	1	EXT	GANCIO 2.05/621 ZNT PER FUSTO TAURUS '03
013	6.205.0022		1	Si	1		KIT DEFLETTORE+BOCCAGLIO
014	3.751.0047		1	Si	1		FUSTO 32LT ACC.INOX AISI 430BA X GANCI PRO
015	4.208.0661		2	Si	1		RUOTA ASPIRATORE SILENT -N- (P82.0564)
016	4.208.0794		1	Si	1		BASE PER FUSTO WINDY 120/130 -GR.SC.- RAL.7016
017	3.754.0017		2	Si	1		RUOTE GEMELLATE PIVOTANTI MAGGIORATE D.50 PERNO ACCIAIO
018	6.205.0017		1	Si	1		KIT TUBO FLEX 4mt + INNESTO GIREV.C/BAIONETTA -LAVOR-
019	3.753.0003		1	Si	1		IMPUGNATURA CURVA PER ACCESSORI D.35 (SP.) 0N100050
020	3.753.0103		1	Si	1		TUBO TELESCOPICO D.35 L=550/910 IN METALLO
021	3.754.0005		1	Si	1	EXT	LANCIA PIATTA D.35
022	3.754.0016		1	Si	1		SPAZZOLA RETTANGOLARE D.35 NER A CROMATA (SP.) 00050056
023	3.754.0249		1	Si	1		SPAZZOLA POLVERE/LIQUIDI ECO D.35
024	7.300.0652		1	No			MANUALE ASPIRATORI WT +CE LAVOR 21L A5 76F
025	5.212.0155		1	Si	1		KIT 1 FILTRO CARTUCCIA LAVABILE X GT/VAC -LAVOR-
026	5.212.0092		1	Si	1		KIT 1 SACCO FILTRANTE POLVERI FINI X ASP.HOBBY -LAVOR-
027	5.212.0049		1	Si	1		KIT 5 FILTRI RACCOGLITORI X GN/GB 32LT LAVOR
028	5.212.0030		1	Si	1		KIT 1 FILTRO SPUGNA X GT -LAVOR-
029	4.208.0063	5.212.0044	1	Si	1		ADATTATORE PER ELETTROUTENSILI L=132 (De. 26-27/31-32/35-36/39-40/49-50)

WT 30 XEL WET&DRY 220-240/50-60 -LAVOR- - Filtri: validità 14/03/2023



R82530009 - WT 30 XEL WET&DRY 220-240/50-60 -LAVOR-

Validità: dal 20/11/2019 al 31/12/9999

14/03/2023

Pag. 5 / 6

Codice	Tavola	Pos.	Q.tà
3.099.0138	R82530009	003	1
3.099.0454	R82530009	012	2
3.403.0026	R82530009	005	1
3.751.0047	R82530009	014	1
3.753.0003	R82530009	019	1
3.753.0103	R82530009	020	1
3.754.0005	R82530009	021	1
3.754.0016	R82530009	022	1
3.754.0017	R82530009	017	2
3.754.0249	R82530009	023	1
3.755.0085	R82530009	008	1
4.012.0353	R82530009	010	1
4.208.0063	R82530009	029	1
4.208.0661	R82530009	015	2
4.208.0692	R82530009	006	1
4.208.0717	R82530009	011	1
4.208.0771	R82530009	004	1
4.208.0772	R82530009	002	1
4.208.0794	R82530009	016	1
5.009.0213	R82530009	001	2
5.211.0040	R82530009	009	1
5.212.0030	R82530009	028	1
5.212.0049	R82530009	027	1
5.212.0092	R82530009	026	1
5.212.0155	R82530009	025	1
6.205.0017	R82530009	018	1
6.205.0022	R82530009	013	1
6.205.0215	R82530009	007	1
7.300.0652	R82530009	024	1